

**WEST
CARTERET
WATER
CORPORATION**



**2023
QUALITY
REPORT**

*This report is available by request or online at www.wcwc.biz
Public Water System ID No. 04-16-040*

OFFICERS

Sheila H. Moore, President (*Ocean*)

Brenda Newman, Vice-President (*Gales Creek*)

Bobby A. Bell, Secretary/Treasurer (*Newport, Ocean*)

DIRECTORS

Daniel Fortin (*Peletier*)

Samuel Gibson (*Bogue*)

C. Earl Salter (*Broad Creek*)

Dr. Steve Pridgen (*Stella*)

Wilson Venters (*Star Hill*)

Pam Rose (*Newport*)

MANAGEMENT

Lisa D. Smith-Perri, General Manager/Executive Director

H. Bryan Wilson, System Manager

In accordance with Federal law and U.S. Department of Agriculture policy, this institution is prohibited from discriminating on the basis of race, color, national origin, sex, age, or disability. (Not all prohibited basis apply to all programs.) To file a complaint of discrimination, write USDA, Director, Office of Civil Rights, 1400 Independence Avenue, SW, Washington, D.C. 20250-9410 or call 800-795-3272 (voice) or 202-720-6382 (TDD). USDA is an equal opportunity provider and employer.

2023 WATER QUALITY REPORT

Why is your water company providing this information?

Several years ago, the EPA decided that water companies should be required to provide their customers with a report about their operations and testing results during the preceding year. At WCWC we have always made this information available and look forward to keeping you informed by providing this Water Quality Report each year. The report includes information about where your water comes from, what it contains, and how it compares to standards set by regulatory agencies. Sections of it may look the same from year to year because there are topics that must be included. Our constant goal is to provide you with a safe and dependable supply of drinking water. We want you to understand the efforts we make to continually improve the water treatment process and protect our water resources.

In addition to water quality and treatment information, we attempt to provide you with billing information, such as rate and procedure changes, and conservation tips. If you are interested in receiving a copy of the report, please contact our office. You may also elect to read it by visiting our website at www.wcwc.biz. The report will be posted no later than July 1, 2024.

Also, if you have any questions or concerns about your water, or suggestions, please contact the General Manager/Executive Director, Lisa Smith-Perri, or any customer service representative at 252-393-1515.



FACEBOOK & WCWC.BIZ

FACEBOOK AND WEB PAGE

Are you on Facebook? We are! **“Like Us”** so you can receive updated information regarding closings, meetings, and other key dates. Also, please check out www.wcwc.biz for important messages, water rates, scheduled outages, emergency repair information, office closings, and forms.

SIGN UP FOR ALERTS!

You can subscribe to receive news and alerts via email or text by visiting our website. Alerts will notify you of any office closings, meetings, key dates, important messages about water outages, and emergency repair information.

ONLINE BILL PAY

Thank you for your patience with our new software upgrade. As challenging as it has been, we have confidence it will benefit the corporation in the future. With the software conversion, if you have not already re-established your draft, please do so by following the the instructions on our website.

You can make a one-time payment with your credit card (Visa, MasterCard, or Discover) or checking account or you can also register your account to access other payment options. By registering your account, you can set-up an automatic draft, schedule payments (one-time or recurring), and access PDF copies of your bills! Questions? Call our office, our staff is happy to help!

WATER RATES

West Carteret Water Corporation has an ascending rate to promote conservation. Water rates are posted on our website or we can mail you a rate schedule. WCWC increased water rates 3% for usage in June 2024 for residential customers that usage is greater than 2,000 gallons. Letters were mailed to bulk metered customers regarding their rate increase based on meter size. As notified in previous mailings, your board decided a few years ago to annually raise rates in hopes of avoiding larger one-time increases; however, it will be evaluated each year based on budgetary needs.

West Carteret Water Corporation			
4102 Hwy 24 Newport, NC 28570 (252) 393-1515 Office (877) 393-6829 Toll Free (252) 393-1540 Fax Monday - Friday, 8:30 am - 4:30 pm After hours, you may receive emergency instructions by calling the office number.			
RATE SCHEDULE			
Effective June 15, 2024 Billing			
3/4" Meter		3" Meter	
\$18.30 Flat Rate/Mo.	Plus	\$8.70/1,000	for 0 - 2,000 Gallons
		\$9.65/1,000	for 2,001 - 8,000 Gallons
		\$10.20/1,000	for 8,001 - 16,000 Gallons
		\$11.55/1,000	for 16,001 - 40,000 Gallons
		\$17.00/1,000	for 40,001 - 100,000 Gallons
		\$24.25/1,000	for 100,001 + Gallons
3/4" Irrigation Meter		4" Meter	
\$18.30 Flat Rate/Mo.	Plus	\$18.00/1,000	for All Usage
1" Meter		6" Meter	
\$57.70 Flat Rate/Mo.	Plus	\$9.40/1,000	for 0 - 12,000 Gallons
		\$9.95/1,000	for 12,001 - 25,000 Gallons
		\$10.75/1,000	for 25,001 - 50,000 Gallons
		\$11.20/1,000	for 50,001 + Gallons
2" Meter		6" Meter	
\$317.25 Flat Rate/Mo.	Plus	\$5.35/1,000	for 0 - 500,000 Gallons
		\$5.65/1,000	for 500,001 - 1,000,000 Gallons
		\$6.10/1,000	for 1,000,001 - 2,000,000 Gallons
		\$6.65/1,000	for 2,000,001 + Gallons

Bills are mailed on the 16th of each month. Payments not received by the due date stated on the bill will be charged a 5% late fee. (Drafts are processed on the due date.) Accounts not paid in full within 10 days after the due date will be subject to a \$20 Additional Penalty. Accounts that are still past due by the last day of the month will be subject to a Delinquent Fee and possible service interruption. If you do not receive your bill or are unable to pay your balance by the due date, please contact our office.

In accordance with Federal law and U.S. Department of Agriculture policy, this institution is prohibited from discriminating on the basis of race, color, national origin, sex, age, or disability. (Not all prohibited bases apply to all programs.) To file a complaint of discrimination, write USDA, Director, Office of Civil Rights, 1400 Independence Avenue, SW, Washington, D.C. 20250-9140 or call (800) 795-3272 (voice) or (202) 720-6382 (TDD). USDA is an equal opportunity provider and employer.

PAYMENT OPTIONS

- In the office, drive-thru or dropbox
- Monthly bank draft
- Telephone using a credit card:
VISA, MasterCard, or Discover
- Mail-in with remittance slip
- On our website at wcwc.biz



PAYMENT EXTENSIONS

Avoid late and interruption fees by remitting payments no later than the 7th of each month. Payment extensions are available upon request three times per year. Contact the office for information.

HIGH WATER USAGE

Are you aware that the residential water rate drastically increases once you use 40,000 gallons and it increases again when your meter registers over 100,000 gallons of monthly usage?

Treated water is expensive when not used wisely! If you must use potable water for washing your car, watering plants, and other outdoor uses, track how much is registered on your meter to avoid any surprises when your bill arrives.

As a reminder, although we have a leak adjustment policy, it does not allow for adjustments where the leak was avoidable, not repaired in a timely manner, or for outdoor appurtenances, such as damaged water hoses, leaking exterior fittings, and so forth.

Opening the Lid to Your Meter Box

1. Locate your meter box. (Hint: Look for the "S" painted on the paved road and walk toward your property. If you cannot find the oblong meter lid, contact the office for assistance.)
2. Insert your screwdriver into the larger hole on top of the lid.
3. Push the screwdriver handle forward (toward the middle of the meter box lid) until the latch releases.
4. When the latch releases, keep pressure on the screwdriver handle and gently pull up on the lid.
5. Gently place the lid upside-down, being extra careful not to damage the wires connected to the MTU (gray box) attached to the lid of the meter. (Note: Your meter may or may not have an MTU attached.)



Closing the Lid to Your Meter Box

1. Gently feed all wires back into the meter box, if applicable.
2. Flip the lid upright (gray box facing down) and place the lid on top of the meter box in the same position you initially found it.
3. Place the screwdriver back in the hole and push the handle forward (toward the middle of the meter box lid) until the latch releases.
4. Gently press down on the lid to ensure that it is even and flush with the ground.
5. Release pressure on the screwdriver and remove it from the hole.

CHECK FOR LEAKS OR HIGH USAGE

1. Locate your water meter and remove the lid.
2. There are digital meters installed throughout the system. If water is going through the meter at the time, the digital meters will indicate the rate of flow to let you know water is going through the meter.
In one mobile home community analog meters (dial-faced meters) are installed. You can check the leak detection triangle.
3. Write down a reading for either type of meter. Repeat after a few hours of no water use.
4. If there is a difference, subtract the readings to determine the amount of usage in that given period of time.
5. Check all toilets, faucets, pipes, and connections. You can isolate the leak location by turning the water off near the home and then repeating steps 1 & 2. If the meter stops moving, then the leak is in the home. If not, it is between the meter and the cut-off valve to the home.
6. Once leaks are located, have them repaired quickly.



THE NEPTUNE/ACLARAONE METER READING SYSTEM FOR WEST CARTERET WATER CORPORATION

Below is an example of the water meters that have been installed throughout the system. This Neptune E-Coder water meter is state-of-the-art with a solid-state absolute encoder register. That means it has no moving parts to wear out. The register shows 7 digits plus 2 more past the decimal for accurate reading down to the 10ths of a gallon. Depending on the model, there is also a leak indicator, a tamper indicator, and a reverse-flow detector/indicator. It even shows the rate of flow when water is being used. This is especially helpful when diagnosing a potential leak.



	<p>FLOW INDICATOR Shows the direction of flow through the meter.</p> <p>ON Water in use. OFF Water not in use. Flashing Water is running slowly. (-) Reverse flow. (+) Forward flow.</p>
	<p>LEAK INDICATOR Displays a possible leak:</p> <p>OFF No leak indicated. Flashing Intermittent leak indicates that water has been used for at least 50 of the 96 15-minute intervals during a 24-hour period. On Continuously Indicates water use for all 96 15-minute intervals during a 24-hour period.</p>
<p>RATE</p>	<p>RATE OF FLOW Average flow rate is displayed every six seconds on LCD display.</p>

We use two models of the AclaraONE system to transmit usage and other data, via Data Collector Units throughout the water system, back to our office. This is done either nightly or hourly depending on the model. The benefit is “real-time” information on your usage and the water system. Graphs and precise daily usage are just a few of the reports that make this system a great customer service tool, while helping the company to track water usage. If you need access to specific information, please call the office.

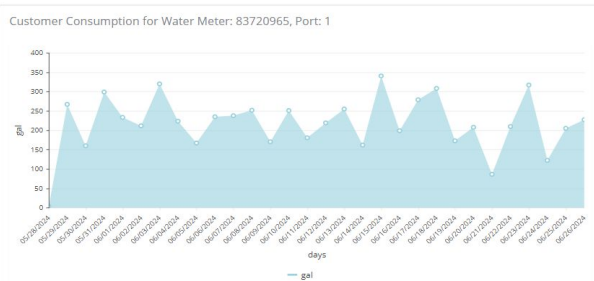

The graph on the left illustrates daily usage for a family of six living in the home.

The graph on the right illustrates the usage for one person in the home.

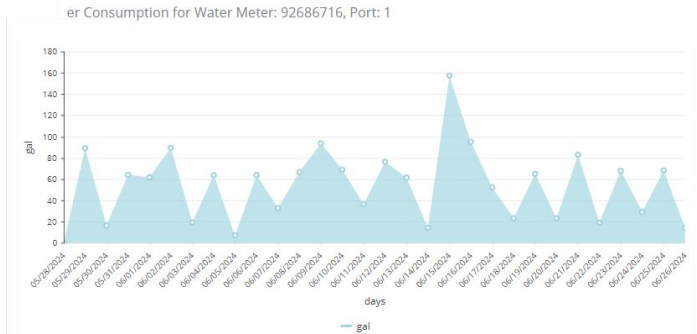

HELP PROTECT YOUR SOURCE WATER

What Is Source Water?

Source water refers to sources of water (such as rivers, streams, lakes, reservoirs, springs, and groundwater) that provide water to public drinking water supplies and private wells.

Why Protect Source Water?

Protecting source water can reduce risks by preventing exposures to contaminated water. Drinking water utilities that meet the definition of a public water system are responsible for meeting the requirements of EPA and state drinking water programs under the Safe Drinking Water Act (SDWA). Protecting source water from contamination helps reduce treatment costs and may avoid or defer the need for complex treatment.

There are many additional benefits associated with source water protection, such as protecting water quality for wildlife and recreational use, and protecting the availability and quantity of water supplies.

Protection of everyone's drinking water is everyone's responsibility.

You can help protect your community's drinking water source(s) in several ways: Dispose of chemicals properly, take used motor oil to a recycling center, volunteer in your community to participate in group efforts to protect your source, etc.



Did you know that your water company has full-time lab technicians on staff? They are either in the field sampling or working in the lab daily! Our Lab Manager, Lisa G, coordinates with both the lab and our flushing staff to bring you the best quality water possible. However, if you ever have concerns or questions about your water, do not hesitate to contact us. We will be happy to make an appointment to meet with you!

Your water company strives to keep your water safe...

In accordance with Federal and State laws, we routinely monitor for over 150 contaminants in your drinking water. All the contaminants that we tested and any detected in the last round of sampling for the particular contaminant group are in this report on pages 12 - 18. The presence of contaminants does not necessarily indicate that water poses a health risk. Unless otherwise noted, the data presented in the tables in this report are from testing completed January 1 through December 31, 2023. The EPA or the State requires us to monitor for certain contaminants less than once per year because the concentrations of these contaminants are not expected to vary significantly from year to year. Some of the data, though representative of the water quality, is more than one year old.



FACTS ABOUT YOUR WATER SUPPLY

Currently, the water supply comes from five (5) 10-inch wells, one (1) 12-inch well and two (2) 6-inch wells located in the Croatan National Forest. The average depth of the wells is 280 feet. The water is pumped from the Castle Hayne Aquifer. The wells are equipped with either 40-hp or 50-hp pumps, which are capable of producing approximately 600 gallons per minute (gpm), with the exception of Wells 2, 3, and 8. Wells 2 and 3 pumps approximately 375 gpm. Well 8 is closest to the plant and is the largest producer at 1,200 gpm. The raw water is pumped to the treatment plant located at 4104 Highway 24 in the community of Ocean. The first treatment process is aeration before being stored in two (2) 50,000-gallon ground storage tanks located adjacent to the plant.

In September 2008, the treatment process added iron removal, which is used as needed, before being softened by utilizing Cation Resin. This process reduces the hardness level to an average range of 40 - 50 ppm (2.3 – 2.9 grains per gallon). After softening, the water continues through a train of color (tannin) removal vessels, which use Anion Resin. The water is then injected with ortho-polyphosphate as needed for corrosion control within the distribution system.

Following this process, chlorination is next in the treatment train. The water is routed to a detention tank before being injected with ammonia. These last two components, chlorine and ammonia, are for disinfection purposes. This process is chloramination, which is used monthly except July 1st through August 30th. During that time, we use chlorine only for maintenance. The water is then stored in three (3) elevated tanks or routed to the distribution system.

West Carteret Water Corporation's customer base consists of residential, commercial, and institutional members. Distribution lines are located from Gethsemane Memorial Park near Morehead City along the Highway 24 corridor to the White Oak River in Cedar Point. Currently, our northernmost distribution lines end at the Stella Bridge. Perpendicular to NC Highway 24, we have water lines installed to the Newport ETJ on both Robert's Road and Nine Foot Road, along with a short distance on Lake Road.



WHAT EPA WANTS YOU TO KNOW!

Drinking water, including bottled water, may reasonably be expected to contain at least small amounts of some contaminants. The presence of contaminants does not necessarily indicate that water poses a health risk. More information about contaminants and potential health effects can be obtained by calling the Environmental Protection Agency's Safe Drinking Water Hotline (800-426-4791).

Some people may be more vulnerable to contaminants in drinking water than the general population. Immuno-compromised persons such as persons with cancer undergoing chemotherapy, persons who have undergone organ transplants, people with HIV/AIDS or other immune system disorders, some elderly, and infants can be particularly at risk from infections. These people should seek advice about drinking water from their health care providers. EPA/CDC guidelines on appropriate means to lessen the risk of infection by *Cryptosporidium* and other microbial contaminants are available from the Safe Water Drinking Hotline (800-426-4791) as well.

If present, elevated levels of lead can cause serious health problems, especially for pregnant women and young children. Lead in drinking water is primarily from materials and components associated with service lines and home plumbing. West Carteret Water Corporation is responsible for providing high quality drinking water, but cannot control the variety of materials used in plumbing components. When your water has been sitting for several hours, you can minimize the potential for lead exposure by flushing your tap for 30 seconds to 2 minutes before using water for drinking or cooking. If you are concerned about lead in your water, you may wish to have your water tested. Information on lead in drinking water, testing methods, and steps you can take to minimize exposure is available from the Safe Drinking Water Hotline or at <http://www.epa.gov/safewater/lead>.

The sources of drinking water (both tap water and bottled water) include rivers, lakes, streams, ponds, reservoirs, springs, and wells. As water travels over the surface of the land or through the ground, it dissolves naturally occurring minerals and, in some cases, radioactive material, and can pick up substances resulting from the presence of animals or from human activity. Contaminants that may be present in source water include:

- **Microbial contaminants**, such as viruses and bacteria, which may come from sewage treatment plants, septic systems, agricultural livestock operations, and wildlife.
- **Inorganic contaminants**, such as salts and metals, which can be naturally occurring or result from urban stormwater runoff, industrial or domestic wastewater discharges, oil or gas production, mining, or farming.
- **Pesticides and herbicides**, which may come from a variety of sources such as agriculture, urban stormwater runoff, and residential uses..
- **Organic chemical contaminants**, including synthetic and volatile organic chemicals, which are by-products of industrial processes and petroleum products, and can also come from gas stations, urban stormwater runoff, and septic systems.
- **Radioactive contaminants**, can be naturally occurring or be the result of oil and gas production and mining activities.

In order to ensure that tap water is safe to drink, the Environmental Protection Agency (EPA) prescribes regulations that limit the amount of certain contaminants in water provided by public water systems. The Food and Drug Administration (FDA) regulations establish limits for contaminants in bottled water that must provide the same protection for public health.



SOURCE WATER ASSESSMENT PROGRAM RESULTS

The North Carolina Department of Environmental Quality (DEQ), Public Water Supply (PWS) Section, Source Water Assessment Program (SWAP) conducted assessments for all drinking water sources across North Carolina. The purpose of the assessments was to determine the susceptibility of each drinking water source (well or surface water intake) to Potential Contaminant Sources (PCSs). The results of the assessment are available in SWAP Assessment Reports that include maps, background information and a relative susceptibility rating of Higher, Moderate or Lower.

The relative susceptibility rating of each source for West Carteret Water Corporation was determined by combining the contaminant rating (number and location of PCSs within the assessment area) and the inherent vulnerability rating (i.e., characteristics or existing conditions of the well or watershed and its delineated assessment area). The assessment findings for the September 2020 report are summarized in the table below:

SUSCEPTIBILITY OF SOURCES TO POTENTIAL CONTAMINANT SOURCES (PCSs)

SOURCE NAME	SUSCEPTIBILITY RATING	SWAP REPORT DATE
Well # 1	Lower	September 2020
Well #2	Lower	September 2020
Well #3	Lower	September 2020
Well #4	Lower	September 2020
Well #5	Lower	September 2020
Well #6	Lower	September 2020

*** Well 7 and Well 8 were certified November 2020**

(Please note that because SWAP results and reports are periodically updated by the PWS Section, the results available on the website may differ from the results that were available at the time this CCR was prepared)

The complete SWAP Assessment report for WCWC may be viewed on the Web at: www.ncwater.org/?pws=600 SWAP results and reports are periodically updated by the PWS Section, the results available on this website may differ from the results that were available at the time this CCR was prepared. To obtain a printed copy of this report, please mail a written request to: **Source Water Assessment Program – Report Request 1634 Mail Service Center, Raleigh NC 27699-1634** or e-mail request to swap@ncdenr.gov. Please indicate our system name, PWSID (04-16-040), and provide your name, mailing address, and phone number. If you have any questions about the SWAP report, please contact the Source Water Assessment staff by phone at: **(919) 707-9098**.

It is important to understand that if a susceptibility rating of “higher” was given, that does not imply poor water quality, only the system’s potential to become contaminated by PCSs in the assessment area.

**Source Water Assessment Program Report for
WEST CARTERET WATER CORP**
Community Water System

TESTING NOTES... UNREGULATED CONTAMINANTS

In the following pages, we have tables that include detected and undetected contaminants in order to make you, the customer, aware of the extent of the testing that is performed. As a note, unregulated contaminants are included in this report as well. The purpose of unregulated contaminant monitoring is to assist EPA in determining the occurrence of such contaminants in drinking water and whether future regulation is warranted. Unregulated contaminants are those for which EPA has not established drinking water standards. If you would like more information on unregulated chemicals, you may call the EPA Hotline.

ABBREVIATIONS & DEFINITIONS

In the test result table located in this report, you will find many terms and abbreviations that might not be familiar to you. To help you better understand these terms, we've provided the following definitions:

Not-Applicable (N/A) – Information not applicable/not required for that particular water system or that particular rule.

Non-Detects (ND) - Laboratory analysis indicates that the contaminant is not present at the level set for the particular methodology.

Parts per million (ppm) or Milligrams per liter (mg/l) - One part per million corresponds to one minute in two years or a single penny in \$10,000.

Parts per billion (ppb) or Micrograms per liter (mg/l) - One part per billion corresponds to one minute in 2,000 years, or a single penny in \$10,000,000.

Parts per trillion (ppt) or Nanograms per liter (nanograms/l) - One part per trillion corresponds to one minute in 2,000,000 years, or a single penny in \$10,000,000,000.

Parts per quadrillion (ppq) or Picograms per liter (pictogram/l) - One part per quadrillion corresponds to one minute in 2,000,000,000 years or one penny in \$10,000,000,000,000.

Picocuries per liter (pCi/L) - Picocuries per liter is a measure of radioactivity in water.

Action Level (AL) - The concentration of a contaminant which, if exceeded, triggers treatment or other requirements which a water system must follow.

Maximum Contaminant Level Goal (MCLG) - Level of a contaminant in drinking water below which there is no known or expected risk to health. MCLGs allow for a margin of safety.

Maximum Contaminant Level (MCL) - Highest allowable contaminant of any substance as set by the USEPA and State Department of Health Services; MCLs are set as close to the MCLGs as feasible using the best available treatment technology.

Maximum Residual Disinfection Level (MRDL) – The highest level of a disinfectant allowed in drinking water. There is convincing evidence that addition of a disinfectant is necessary for control of microbial contaminants.

Maximum Residual Disinfection Level Goal (MRDLG) – The level of a drinking water disinfectant below which there is no known or expected risk to health. MRDLGs do not reflect the benefits of the use of disinfectants to control microbial contaminants.

Locational Running Annual Average (LRAA) – The average of sample analytical results for samples taken at a particular monitoring location during the previous four calendar quarters under the Stage 2 Disinfectants and Disinfection Byproducts Rule.

Running Annual Average (RAA) – The average of sample analytical results for samples taken during the previous four calendar quarters.

Field Trip Blank (FTB) - A sample of analyte-free media taken from the laboratory to the sampling site and returned to the laboratory unopened. A trip blank is used to document contamination attributable to shipping and field handling procedures.

Secondary Contaminants, required by the NC Public Water Supply Section, are substances that affect the taste, odor, and/or color of your drinking water. These aesthetic contaminants normally do not have any health effects and normally do not affect the safety of your water.

Water Characteristics Contaminants - February 2021 (Every 3 Years)				
Contaminant (units)	Sample Date	Your Water	Range Low High	Secondary MCL
Iron (ppm)	02/16/21	ND	N/A	0.3 mg/L
Manganese (ppm)	02/16/21	ND	N/A	0.05 mg/L
Nickel (ppm)	02/16/21	ND	N/A	N/A
Sodium (ppm)	02/16/21	120.140	N/A	N/A
pH	02/16/21	7.5	N/A	6.5 to 8.5



TESTING RESULTS

This company tests for many contaminants, both regulated and unregulated. The results for both are listed below. A “ND” refers to non-detects. The maximum Contaminant Levels (MCL) are set at very stringent levels.

Microbiological Contaminants-

20 per month required TESTING Fecal Coliform (E. coli) - Non-detect 2022

Contaminant (units)	MCL Violation Y/N	Your Water	MCLG	MCL	Likely Source of Contamination
Total Coliform Bacteria (presence or absence)	N	0	0	1 positive monthly sample	Naturally present in the environment
Fecal Coliform or E.colli (present or absence)	N	0	0	1 positive sample/month Note: if either an original routine sample and/or its repeat sample(s) are fecal coliform or E.colli positive, a Tier 1 violation exists.	Human and animal fecal waste

Nitrate/Nitrite Contaminants - February 2023 (Yearly) TESTING (ND): Nitrate

Chloride Testing - October 2023: Wells 1, 2, 3, 5, 6, 7, & 8; Range was 8-10 ppm of Chlorides. (Next yearly test 2024)

Inorganics Contaminants - February 2021 (Every 3 Years; Next Test 2024)

Contaminant (units)	Sample Date	MCL Violation Y/N	Your Water	Range Low High	MCLG	MCL	Likely Source of Contamination
Fluoride (ppm)	2/16/21	N	0.20	N/A	4	4	Erosion of natural deposits; water additive which promotes strong teeth; discharge from fertilizer and aluminum factories

Additional Testing (ND): Arsenic, Barium, Cadmium, Chromium, Cyanide, Manganese, Mercury, Nickel, Selenium, Antimony, Beryllium, Thallium, Iron, Sulfate

JUST A LITTLE WATER CHATTER ABOUT HARDNESS AND FLUORIDE...

Hardness... Total hardness is defined as the sum of the calcium and magnesium concentrations (or salts). Both of these are expressed as calcium carbonate in units of milligrams per liter. Calcium is the major component of hardness in water. It is present in many minerals, principally limestone and gypsum. There is no U.S. EPA drinking water MCL for hardness. Silica (SiO₂) is found in crystalline (quartz, rock crystal amethyst and microcrystalline) formations. In the presence of Magnesium, it can form a scale. There is no U.S. EPA drinking water MCL for Silica. Evidence of both Calcium and Silica may be observed as water dries on or near fixtures.

The average (untreated) concentration of calcium carbonate from the wells at West Carteret Water Corporation is approximately 250 ppm. The water is softened to 62.1 ppm on average before entering the distribution system. This is considered to be a moderately hard range of water. Softened water can be corrosive to certain types of plumbing. Therefore, the moderately hard range has been chosen to minimize problems from occurring in the distribution system and customer's plumbing. A further reduction of calcium carbonate can be managed by the customer installing one of many varieties of water softeners that are available on the market today.

Fluoride... In October 2023, Fluoride was tested at each well. Seven wells tested at a range from 0.15 – 0.17 ppm of naturally occurring fluoride. (Tested yearly)

SYNTHETIC ORGANIC CHEMICAL (SOC) Contaminants including Pesticides and Herbicides

April, July, and November 2023 (ND) Next test April and July 2026)

PARAMETERS TESTED (ND):

Alachlor, Atrazine, Benzo(a)pyrene (PAH), Carbofuran, Chlordane, Dalapon, Di(2-ethylhexyl)adipate, Di(2-ethylhexyl)phthalate, Dinoseb, Endrin, Ethylene Dibromide (EDB), Heptachlor, Heptachlor epoxide, Hexachlorobenzene, Hexachlorocyclopentadiene, Methoxychlor, Oxamyl [Vydate], PCBs [as decachlorobiphenyl], Picloram, 2,4,5-TP (Silvex), Simazine, Toxaphene, 2,4-D (ppb), Pentachlorophenol (ppb), Gamma (BHC), Dibromochloropropane (DBCP).

VOLATILE ORGANIC CHEMICAL CONTAMINANTS (VOC)

February 2023 (Next test 2026)

PARAMETERS TESTED (ND):

1,2,4 –Trichlorobenzene, c-1,2-Dichloroethylene, Xylenes, Dichloromethane, o-Dichlorobenzene, p-Dichlorobenzene, Vinyl Chloride, 1,1-Dichloroethylene, t-1,2-Dichloroethylene, 1,2-Dichloroethane, 1,1,1-Trichloroethane, Carbon Tetrachloride, 1,2-Dichloropropane, Trichloroethylene, 1,1,2-Trichloroethane, Chlorobenzene, Benzene, Toluene, Ethylbenzene, Styrene, Tetrachloroethylene

Radiological Contaminants- March, June, September, and November 2021

(Due to system expansion in 2020, additional quarterly sampling was required for 2021. (Next test 2029))

Contaminant (units)	Sample date	MCL Violation Y/N	Your Water	Range Low High	MCLLG	MCL	Likely Source of Contamination
Alpha emitters (pCi/L)	03/23/21 06/09/21 08/04/21 10/05/21	N	ND	ND	0	15	Erosion of natural deposits
Beta/photon emitters (pCi/L)	03/23/21 06/09/21 08/04/21 10/05/21	N	ND	ND	0	50*	Decay of natural and man-made deposits
Combined radium (pCi/L)	03/23/21 06/09/21 08/04/21 10/05/21	N	ND	ND	0	5	Erosion of natural deposits
Uranium (pCi/L)	03/23/21 06/09/21 08/04/21 10/05/21	N	ND	ND	0	20.1	Erosion of natural deposits

*Note: The MCL for beta/photon emitters is 4 mrem/year. EPA considers 50 pCi/L to be the level of concern for beta particles.

Disinfectant Residuals Summary 2023

	Year Sampled	MRDL Violation Y/N	Highest RAA Your Water	Range Low - High	MRDLG	MRDL	Likely Source of Contamination
Chloramines (ppm) [Total]	2023	N	3.35 (10 months/yr)	1.5 - 4.0	4	4	Water additive used to control microbes
Chlorine (ppm) [Free]	2023	N	2.50 (2 months/yr)	1.0 - 4.0	4	4	Water additive used to control microbes

Disinfection By-Product Contaminants - Stage 2

(Next quarterly test 2024) - Based on locational running annual average.

	Year Sampled	MCL Violation Y/N	Your Water (highest LRAA)	Range Low-High **	MCLG	MCL	Likely Source of Contamination
TTHM (ppb)							
B01-STELLA BRIDGEVIEW	2023	N	42	37 - 52	N/A	80	Byproduct of drinking water disinfection
B02-HIBBS ROAD	2023	N	33	27 - 36	N/A	80	Byproduct of drinking water disinfection
B03-DUDLEY'S MARINA	2023	N	35	27 - 44	N/A	80	Byproduct of drinking water disinfection
B04-HADNOT CREEK	2023	N	36	32 - 39	N/A	80	Byproduct of drinking water disinfection
HAA5 (ppb)							
B01-STELLA BRIDGEVIEW	2023	N	39	32 - 46	N/A	60	Byproduct of drinking water disinfection
B02-HIBBS ROAD	2023	N	32	27 - 38	N/A	60	Byproduct of drinking water disinfection
B03-DUDLEY'S MARINA	2023	N	33	31 - 37	N/A	60	Byproduct of drinking water disinfection
B04-HADNOT CREEK	2023	N	34	31 - 37	N/A	60	Byproduct of drinking water disinfection

UNREGULATED CONTAMINANT MONITORING RULE (UCMR)

EPA has implemented the Unregulated Contaminant Monitoring Rule (UCMR) to collect data for contaminants that are suspected to be present in drinking water and do not have health-based standards set under the Safe Drinking Water Act. EPA uses the results of UCMR monitoring to learn more about the occurrence of unregulated contaminants in drinking water and to decide whether or not these contaminants will be regulated in the future. SWDA requires that once every 5 years the EPA issue a new list of no more than 30 unregulated contaminants to be monitored by PWS.

UNREGULATED CONTAMINANTS (UCMR 4)

We performed monitoring and reported the analytical results of the monitoring to EPA in accordance with its Fourth Unregulated Contaminant Occurrence Database (NCOD) (<http://www.epa.gov/dwusmr/national-contaminant-occurrence-database-ncod>) Consumers can review UCMR results by accessing the NCOD. Contaminants that were detected during our UCMR4 sampling and the corresponding analytical results are provided below.

More information about the contaminants that were included in UCMR4 monitoring can be found at: <http://www.drinktap.org/water-info/whats-in-my-water/unregulated-contaminant-monitoring-rule.aspx>. Learn more about the EPA UCMR at: <http://www.epa.gov/dwucmr/learn-about-unregulated-contaminant-monitoring-rule> or contact the Safe Drinking Water Hotline at (800) 426-4791 or <http://water.epa.gov/drink/contact.cfm>

Contaminant Name May & November 2019 118 Stella Bridgeview - WCWC	Year	Average	Range Low - High	Unit of Measure
Bromochloroacetic Acid	2019	ND	1.13 – 1.52	ug/L
Bromodichloroacetic Acid	2019	ND	0.693 – 0.870	ug/L
Dichloroacetic Acid	2019	ND	8.98 – 12.2	ug/L
Trichloroacetic Acid	2019	ND	7.02 – 9.04	ug/L

800 Hibbs Road	Year	Average	Range Low - High	Unit of Measure
Bromochloroacetic Acid	2019	ND	1.24 – 1.25	ug/L
Bromodichloroacetic Acid	2019	ND	0.684	ug/L
Dichloroacetic Acid	2019	ND	12.3 – 12.4	ug/L
Trichloroacetic Acid	2019	ND	8.93 – 9.70	ug/L

Raw Water – WCWC Treatment Plant	Year	Average	Range Low - High	Unit of Measure
Bromide	2019	ND	29.2 – 35.3	ug/L
Total Organic Carbon	2019	ND	6240 - 7270	ug/L

UCMR4

Additional Testing (ND): N-ethyl Perfluorooctanesulfonamidoacetic acid, N-methyl Perfluorooctanesulfonamidoacetic acid, Perfluorobutanesulfonic acid (PFBS), Perfluorodecanoic acid (PFDA), Perfluoroheptanoic acid (PFHpA), Perfluorohexanesulfonic acid (PFHxS), Perfluorohexanoic acid (PFHxA), Perfluorododecanoic acid (PFDoA), Perfluorotetradecanoic acid (PFTeDA), Perfluorononanoic acid (PFNA), Perfluorooctanesulfonic acid (PFOS), Perfluorooctanoic acid (PFOA), Perfluorotridecanoic acid (PFTrDA), Perfluoroundecanoic acid (PFUnA), HFPO-DA/GenX, ADONA, 9CI-PF3ONS/F-53B Major, 11CI-PF3OUdS/F-53B Minor.

UCMR5 - Proposed Testing July 2024 & January 2025

PFAS TESTING (SPECIAL)

Well 1, was tested for Perfluorooctanoic acid (PFAS) after being placed back in service on January 25, 2023. On August 23, 2023, Wells 1, 2, 3, 5, 6, 7, & 8 were tested for Perfluorooctanoic acid (PFAS). No contaminants were detected.

Analyte	Result	Unit
Perfluorobutanoic acid (PFBA)	<2.0	ng/L
Perfluoropentanoic acid (PFPeA)	<2.0	ng/L
Perfluorohexanoic acid (PFHxA)	<2.0	ng/L
Perfluoroheptanoic acid (PFHpA)	<2.0	ng/L
Perfluorooctanoic acid (PFOA)	<2.0	ng/L
Perfluorononanoic acid (PFNA)	<2.0	ng/L
Perfluorodecanoic acid (PFDA)	<2.0	ng/L
Perfluoroundecanoic acid (PFUnA)	<2.0	ng/L
Perfluorododecanoic acid (PFDoA)	<2.0	ng/L
Perfluorobutanesulfonic acid (PFBS)	<2.0	ng/L
Perfluoropentanesulfonic acid (PFPeS)	<2.0	ng/L
Perfluoroheptanesulfonic acid (PFHpS)	<2.0	ng/L

Analyte (Continued)		Result	Unit
Perfluorooctanesulfonic acid	(PFOS)	<2.0	ng/L
Perfluoro (2-ethoxyethane) sulfonic acid	(PFEEESA)	<2.0	ng/L
1H, 1H, 2H, 2H-Perfluorohexane sulfonic acid	(4:2 FTS)	<2.0	ng/L
1H, 1H, 2H, 2H-Perfluorooctane sulfonic acid	(6:2 FTS)	<2.0	ng/L
1H, 1H, 2H, 2H-Perfluorodecane sulfonic acid	(8:2 FTS)	<2.0	ng/L
Hexafluoropropylene Oxide Dimer Acid	(HFPO-DA)	<2.0	ng/L
4,8-Dioxa-3H-perfluorononanoic acid	(ADONA)	<2.0	ng/L
9-Chlorohexadecafluoro-3-oxanonan 3-1-sulfonic acid		<2.0	ng/L
11-Chloroeicosafluoro-3-oxaundecan e-1-sulfonic acid		<2.0	ng/L
Perfluoro-4-methoxybutanoic acid	(PFMBA)	<2.0	ng/L
Perfluoro-3-methoxybutanoic acid	(PFMPA)	<2.0	ng/L
Nonafluoro-3, 6-dioxahepanoic acid	(NFDHA)	<2.0	ng/L

LEAD AND COPPER

If present, elevated levels of lead can cause serious health problems, especially for pregnant women and young children. West Carteret Water Corporation is responsible for providing high quality drinking water, but cannot control the variety of materials used in plumbing components. When your water has been sitting for several hours, you can minimize the potential for lead exposure by flushing your tap for 30 seconds to 2 minutes before using water for drinking or cooking. If you are concerned about lead in your water, you may wish to have your water tested. Information on lead in drinking water, testing methods and steps you can take to minimize exposure is available from the Safe Drinking Water Hotline or at <http://www.epa.gov/safewater/lead>.

Lead and Copper Contaminants - 2023 (30 samples per year every 3 years; Next test 2026)

Contaminant (units)	Sample Date	Your Water	# of sites found above the AL	MCLG	MCL	Likely Source of Contamination
Copper (ppm) (90 th percentile)	June 2023	0.294	0	1.3	AL=1.3	Corrosion of household plumbing systems; erosion of natural deposits; leaching from wood preservatives
Lead (ppb) (90 th percentile)	June 2023	ND	0	0	AL=15	Corrosion of household plumbing systems, erosion of natural deposits

Do you need a **RPZ** for Cross Connection Prevention?

Public Water Supply requires that all public water systems have an active cross connection control plan (CCCP) and a certified operator employed to ensure the protection of your water system from contamination. A cross-connection is illegal and can be found where an approved water source is connected with an unapproved water source or potentially harmful connection. Backflow preventers keep water from re-entering the public water system's lines once it has passed through the meter. West Carteret Water Corporation has always provided some form of backflow prevention devices. In the development of a cross connection control policy, where possible, we have used the guidance of Public Water Supply, the Environmental Protection Agency, and the Plumbing Code.

Since the purpose of this policy is to protect the water system and customers from potentially harmful sources in the event of backsiphonage or backflow, West Carteret Water Corporation began requiring a reduced pressure zone backflow preventer (RPZ) when we developed our CCCP policy in 2006. The RPZ must be used at all commercial accounts, as well as, residential accounts that provide water to irrigation systems, swimming pools, and docks along with other potential hazards. The account holder is required to install an AWWA (American Water Works Association) and USC (University of Southern California) approved RPZ backflow preventer using the following guidelines:

Installation

1. When contracted by the account holder, the installation must be completed by a licensed plumber.
2. The RPZ must be installed within 5 feet of the water meter using an ASSE 1013 approved RPZ model.
 - i. Residential
 - ii. Commercial – To be specified and/or provided by WCWC. The latter is subject to applicable fees.
3. No other connections will be allowed between the meter and RPZ.
4. The RPZ should be covered and properly anchored to the ground or a concrete pad. Always allow for proper box drainage according to RPZ manufacture specifications.
5. The cover must be ASSE 1060 approved and have adequate access for maintenance and testing.
6. Additional insulation is advised to prevent damage from cold weather. However, insulation efforts should not hinder the ability to test the device.

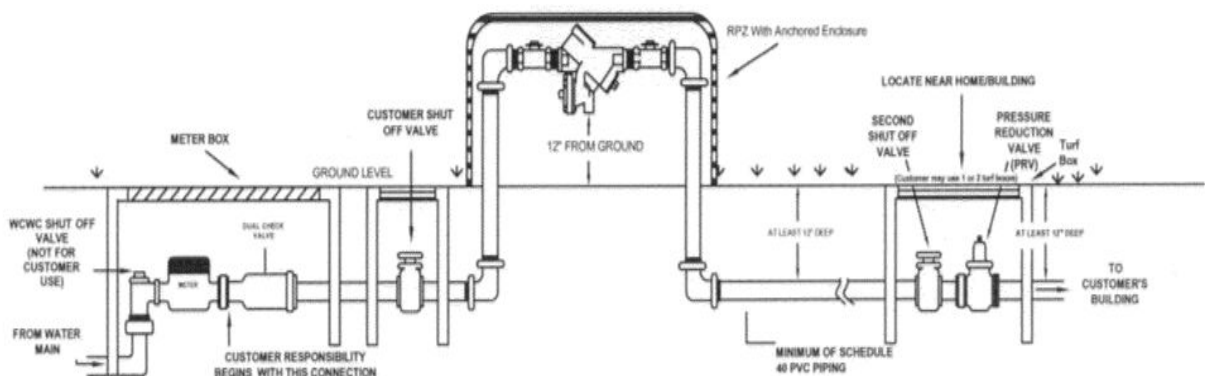

RPZ Testing and Certification

- A. Public Water Supply and WCWC require that these devices be tested immediately after installation and then on a yearly basis thereafter.
- B. This procedure must be handled by a certified backflow cross connection tester who must also be approved by our Operator in Responsible Charge. (Since their certifications must be renewed, contact our office for a current listing of approved testers and installers.)
- C. Once tested, a copy of the testing report must be provided to WCWC. This requirement will be considered delinquent if testing results are not provided within 30 days following the anniversary testing date. For past due inspections, WCWC will contact a certified tester and the charges along with administrative fees will be billed to the customer's account.

RPZ Retest Certifications for Failed Devices

- A. When a RPZ does not pass inspection, it must be repaired by a certified tester or plumber immediately.
- B. Afterwards, it must be tested following the guidelines provided.

The initial deadline for this installation was July 1, 2007 and has been extended each year due to the expense and high demand. RPZs can be fairly expensive to install if contracted. Because of this, your Board of Directors has extended in the past, but request that everyone comply as quickly as possible to prevent a possible interruption of service at some point in the future.

Contact the office for more information at (252) 393-1515.

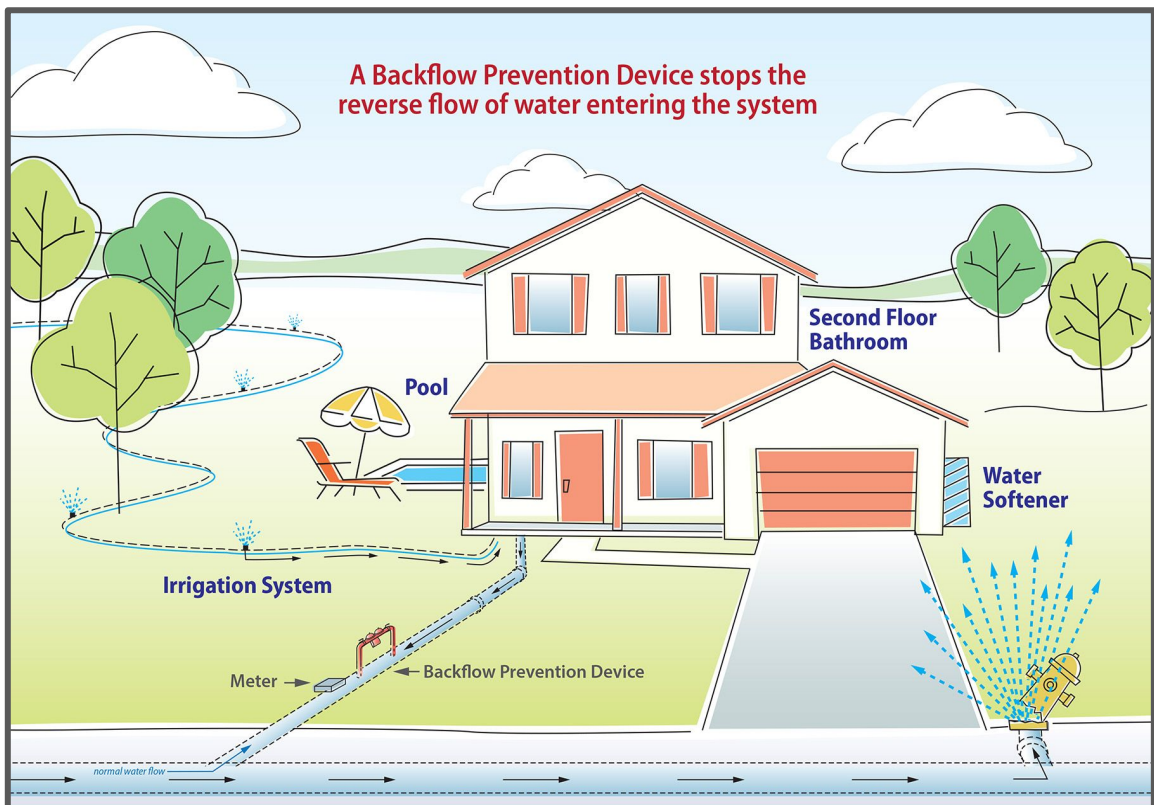



Hurricane Preparedness

June 1 to November 30 (Each Year)

You can't stop a tropical storm or hurricane. But, you can take steps now to protect yourself and your family.

(www.cdc.gov/nceh/features/hurricanepreparedness)

Category	Sustained Winds	Types of Damage Due to Hurricane Winds
1	74-95 mph 64-82 kt 119-153 km/h	Very dangerous winds will produce some damage: Well-constructed frame homes could have damage to roof, shingles, vinyl siding and gutters. Large branches of trees will snap and shallowly rooted trees may be toppled. Extensive damage to power lines and poles likely will result in power outages that could last a few to several days.
2	96-110 mph 83-95 kt 154-177 km/h	Extremely dangerous winds will cause extensive damage: Well-constructed frame homes could sustain major roof and siding damage. Many shallowly rooted trees will be snapped or uprooted and block numerous roads. Near-total power loss is expected with outages that could last from several days to weeks.
3 (major)	111-129 mph 96-112 kt 178-208 km/h	Devastating damage will occur: Well-built framed homes may incur major damage or removal of roof decking and gable ends. Many trees will be snapped or uprooted, blocking numerous roads. Electricity and water will be unavailable for several days to weeks after the storm passes.
4 (major)	130-156 mph 113-136 kt 209-251 km/h	Catastrophic damage will occur: Well-built framed homes can sustain severe damage with loss of most of the roof structure and/or some exterior walls. Most trees will be snapped or uprooted and power poles downed. Fallen trees and power poles will isolate residential areas. Power outages will last weeks to possibly months. Most of the area will be uninhabitable for weeks or months.
5 (major)	157 mph or higher 137 kt or higher 252 km/h or higher	Catastrophic damage will occur: A high percentage of framed homes will be destroyed, with total roof failure and wall collapse. Fallen trees and power poles will isolate residential areas. Power outages will last for weeks to possibly months. Most of the area will be uninhabitable for weeks or months.

<https://www.nhc.noaa.gov/aboutsshws.php>

Hurricane season is fast approaching. In the event of an emergency, if you stay at home, conserve water. WCWC does not make adjustments for these types of leaks.

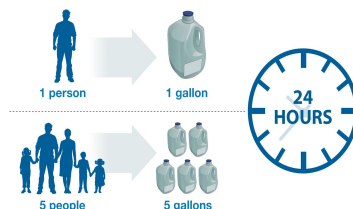

PREP TO SAVE WATER SUPPLY DURING A HURRICANE

If you are a WCWC customer and do not live locally or if you plan to evacuate, cut the water off using your personal shut-off valve next to your water meter box. If you cannot do so, WCWC will handle it for you at your request. Call the office at 252-393-1515 before a major storm or email water@wcwc.biz. There is no cost for this service.

Docks. Outdoor showers. Irrigation systems. Outbuildings. **DO NOT LEAVE WATER ON!** Historically, leaks in these types of plumbing have been the source of high usage following damaging winds and/or downed trees. (We do not offer an adjustment for high usage due to inclement weather where it could have been prevented by cutting off the supply in advance. More importantly, leaks contribute to depleting the elevated tanks.)

WCWC does have generated power at the plant and at least two wells. Elevated tanks will be kept as full as possible. You will remain with limited supply unless one of the following occurs:

1. Catastrophic damage to treatment facilities.
2. Damages to either WCWC's or customers' water lines are so extensive that we cannot pump more than the system is losing. (Before and during any storm, conserve water to help keep the tanks full. Following a storm, continue to conserve water until all damage has been assessed not only to West Carteret Water Corporation's infrastructure, but to customers' water lines.)
3. High winds threaten tanks, which are being depleted by wasteful usage or excessive leaks.
4. Toppled trees/debris prevent us from readily accessing generators in the well field, which is in the forest. (We have equipment available to remove such debris once it is safe for our employees, but it takes time.)

Our staff will be keeping a very close eye on the major storm systems. We must emphasize that you should call us if you need assistance to turn off your water.

<https://www.weather.gov/wrm/hurricane-supplies>

Hurricane Preparedness
Assemble Disaster Supplies

Food & water

Medicine & prescriptions

Keep gas tank full

Cash on hand

Radio, batteries, phone chargers

Emergency Preparedness Checklist

- Flashlight
- Batteries
- Water Bottles
- Radio











weather.gov

The graphic features a dark background with yellow and white text and icons. On the left, there is a photograph of a hand holding a yellow pen over a checklist titled 'Emergency Preparedness Checklist'. The checklist items are 'Flashlight', 'Batteries', 'Water Bottles', and 'Radio'. To the right of the photo are six icons with corresponding text: a water bottle for 'Food & water', a pill for 'Medicine & prescriptions', a gas pump for 'Keep gas tank full', a dollar sign for 'Cash on hand', a radio for 'Radio, batteries, phone chargers', and the NOAA logo for 'weather.gov'.



Emergency Kit

Visual Checklist for Disaster Supplies

 Water	 Food	 Prescription Medications	 First Aid Kit	 Baby Supplies	 Pet Supplies	 Bleach & Eye-dropper
 Mylar Blanket	 Blankets	 Sleeping Bag	 Glasses & Eye Protection	 Extra Clothing	 Personal Hygiene	 Towelettes
 Towels	 Sanitation	 Plastic Sheeting	 Tube Tent	 Backpack	 Dust Mask	 Work Gloves
 Flashlight	 Batteries	 Matches	 Candles	 Lightsticks	 Knife	 Multi-purpose Tool
 Wrench, Pliers, Crowbar	 Rope / Cord	 Duct Tape	 Can Opener	 Kitchen Items	 Scissors	 Fire Extinguisher
 Compass	 Pen & Paper	 Radio	 Cell Phone & Charger	 Whistle	 Signal Mirror	 2-way Radios
 Emergency Guide/Plan	 Family Documents	 Maps	 Camera	 Games & Books	 Extra Keys	 Cash, Travelers Checks, Coins

References



You may need to survive on your own after an emergency. This means having your own food, water, and other supplies in sufficient quantity to last for at least three days. Local officials and relief workers will be on the scene after a disaster, but they cannot reach everyone immediately. You could get help in hours, or it might take days. In addition, basic services such as electricity, gas, water, sewage treatment, and telephones may be cut off for days, or even a week or longer.

Ready America

1. Get a kit
2. Make a plan
3. Be informed

Checklist prepared with guidance from Craig Baldwin, Tracy Burt, Abigail Cerniak, Michelle Gregory, Hidehiko Kanegai PhD, Andy Parish, Lisa Peltier, Mari Srinivas PhD, June Stegner, Tomoko Sugitani and Bob Weil.

Spring 2011



Emergency Comfort Kit Guide
www.stepsinplanning.com/comfort_kit.pdf





Pet Disaster Kit: Easy As 1-2-3!

Do you have an emergency preparedness plan for your pet? Planning ahead doesn't cost anything, but it does help keep you and your family safe during an emergency. Use this easy guide to make a simple and effective plan for your pet.

Step 1. DOCUMENTS

Gather important information. Store hard copies in a safe space with this checklist.



- Photocopied veterinary records
- Rabies certificate
- Vaccinations
- Medical summary
- Prescriptions for medications
- Most recent heartworm test result (for dogs)
- Most recent FeLV/FIV test result (cats)
- Photocopied registration information (ex: proof of ownership or adoption records)
- Pet description(s) (ex: name, breed, sex, color, and weight):

- Recent photographs for each of your pets
- Waterproof container for documents
- Microchip information (ex: microchip number, name and number of the microchip company)
- Important contact information (name, phone, and address)



U.S. Department of
Health and Human Services
Centers for Disease
Control and Prevention

Step 2. FOOD, WATER, AND MEDICATIONS

Put together a kit with these essential items. Keep it ready to go in case you have to evacuate quickly.



- 2-week supply of food for each animal stored in waterproof containers
- 2-week supply of water for each animal
- Non-spill food and water dishes
- Manual can opener
- Feeding instructions for each animal
- 2-week supply of any medications (if applicable)
- Medication instructions (if applicable)
- One month supply of flea, tick, and heartworm preventative

Step 3. OTHER SUPPLIES

Finish your kit by adding other important items.



- Leash, collar with ID, and harness
- Toys
- Appropriate-sized pet carrier with bedding, blanket, or towel
- Pet first aid book and first aid kit
- Cleaning supplies for accidents (paper towels, plastic bags, and disinfectant)
- Litterbox and litter (cats)



CS136052-8

HELPFUL HINTS TO CONSERVE WATER

In the Kitchen

- When washing dishes by hand, don't let the water run while rinsing. Fill one sink with wash water and the other with rinse water.
Some refrigerators, air conditioners, and ice makers are cooled with wasted flows of water. Consider upgrading with air-cooled appliances for significant water savings.
- Never run the dishwasher without a full load. This practice will save water, energy, detergent, and money.
- Use the garbage disposal sparingly. Compost vegetable food waste instead and save gallons every time.
- For cold drinks, keep a pitcher of water in the refrigerator instead of running the tap.
- Use a small pan of cold water when cleaning vegetables, rather than letting the water run over them. Then, collect the water you use for rinsing fruits and vegetables, and reuse it to water house plants.
- Use only a little water in the pot and put a lid on it for cooking most food. Not only does this method save water, but food is more nutritious since vitamins and minerals are not poured down the drain with the extra cooking water.
- Designate one glass for your drinking water each day or refill a water bottle. This will cut down on the number of glasses to wash.
- Don't use running water to thaw food. Defrost food in the refrigerator for water efficiency and food safety.
- If your dishwasher is new, cut back on rinsing. Newer models clean more thoroughly than older ones.
- If you accidentally drop ice cubes when filling your glass from the freezer or when you have ice left in your cup from a take-out restaurant, don't throw it in the trash, dump it on a plant, instead.
- Always keep water conservation in mind, and think of other ways to save in the kitchen. Making too much coffee or letting ice cubes melt in the sink can add up over time. By making these small changes in the kitchen, you can count on bigger savings on your yearly water bill.

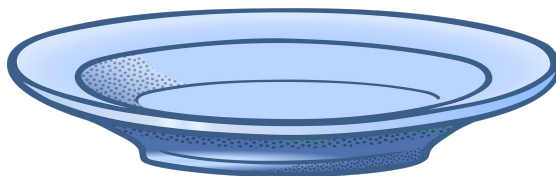

HELPFUL HINTS TO CONSERVE WATER

In the Bathroom

- Shorten your shower by a minute or two and you'll save up to 150 gallons per month.
- Turn off the water while brushing your teeth and save 25 gallons a month.
- Take a shower instead of taking a bath. Showers with low-flow shower heads use less water than taking a bath.
- Turn off the water while you wash your hair to save up to 150 gallons a month.
- Reduce the level of the water being used in a bathtub by one or two inches if a shower is not available.
- When remodeling a bathroom, install a new low-volume flush toilet that uses only 1.6 gallons per flush.
- Test toilets for leaks. Add a few drops of food coloring or a dye tablet to the water in the tank, but do not flush the toilet.
- Watch to see if the coloring appears in the bowl within a few minutes. If it does, the toilet has a silent leak that needs to be repaired.
- Use a toilet tank displacement device such as a toilet dam or bag. Another alternative is filling a plastic bottle with stones or water, recapped, and placed in the toilet tank. These devices will reduce the volume of water in the tank but will still provide enough for flushing. Displacement devices are not recommended with new low-volume flush toilets.
- Never use the toilet to dispose of cleansing tissues, cigarette butts, or other trash. This wastes a great deal of water and also places an unnecessary load on the sewage treatment plant or septic tank.
- Do not let the water run when washing hands. Water should be turned off while washing and scrubbing and be turned on again to rinse. A cutoff valve may be installed on the faucet.
- When shaving, fill the lavatory basin with hot water instead of letting the water run continuously.
- Place water-saving aerators on all of your faucets.



HELPFUL HINTS TO CONSERVE WATER

In the Laundry

- Use your clothes washer only when it is full. This will save up to 500 gallons a month.
- Washing dark clothes in cold water saves both water and energy while it helps your clothes to keep their colors.
- When doing laundry, match the water level to the size of the load.

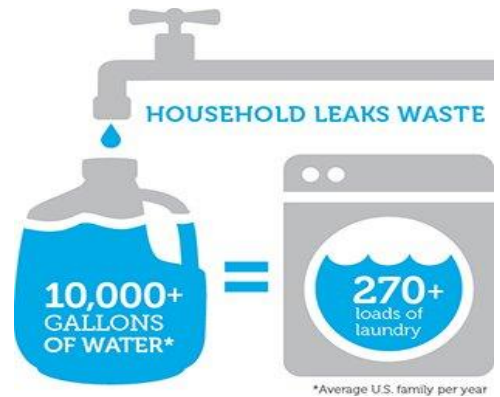

<https://www.epa.gov/watersense/start-saving>

Plumbing and Appliances

- Use your dishwasher only when it is full. This will save up to 500 gallons a month.
- Check water requirements of various models and brands when considering purchasing any new appliances. Some use less water than others.
- Check all waterline connections and faucets for leaks. A slow drip can waste as much as 170 gallons of water EACH DAY, or 5,000 gallons per month, and will add to the water bill.
- Learn to repair faucets so that drips can be corrected promptly. It is easy to do, costs very little, and can mean a substantial savings in plumbing and water bills.
- Check for hidden water leakage such as a leak between the water meter and the house. To check, turn off all indoor and outdoor faucets and water-using appliances. The water meter should be read at 10 to 20 minute intervals. If it continues to run or turn, a leak probably exists and needs to be located.
- Insulate all hot water pipes to reduce the delays (and wasted water) experienced while waiting for the water to "run hot."
- Use a moisture meter to determine when house plants need water. More plants die from over-watering than from being on the dry side.
- Winterize outdoor spigots and faucets when cold temperatures arrive to prevent pipes from freezing and bursting.

HELPFUL HINTS TO CONSERVE WATER

For Outdoor Use

- Water only when needed. Look at the grass, feel the soil, or use a soil moisture meter to determine when to water.
- Do not over-water. Soil can hold only so much moisture, and the rest simply runs off. A timer will help, and either a kitchen timer or an alarm clock will do. Apply only enough water to fill the plant's root zone. Excess water beyond that is wasted. One and a half inches of water applied once a week in the summer will keep most grasses alive and healthy.
- Water lawns early in the morning during the hotter summer months. Otherwise, much of the water used on the lawn can simply evaporate between the sprinkler and the grass.
- To avoid excessive evaporation, use a sprinkler that produces large drops of water, rather than a fine mist. Sprinklers that send droplets out on a low angle also help control evaporation. Adjust sprinkler heads as necessary, to avoid waste, runoff and ensure proper coverage.
- Set automatic sprinkler systems to provide thorough, but infrequent watering. Pressure-regulating devices should be set to design specifications. Rain shut-off devices can prevent watering in the rain.
- Water slowly for better absorption, and never water on a windy day.
- Condition the soil with mulch or compost before planting grass or flowerbeds so that water will soak in rather than run off.
- Fertilize lawns at least twice a year for root stimulation, but do not over-fertilize. Grass with a good root system makes better use of less water and is more drought-tolerant.
- Do not scalp lawns when mowing during hot weather. Taller grass holds moisture better. Grass should be cut fairly often, so that only 1/2 to 3/4 inch is trimmed off. A better-looking lawn will result.
- Use a watering can or hand water with the hose in small areas of the lawn that need more frequent watering (those near walks or driveways or in especially hot, sunny spots.)
- Use water-wise plants. Learn what types of grass, shrubbery, and plants do best in the area and in which parts of the lawn, and then plant accordingly. Choose plants that have low water requirements, are drought-tolerant, and are adapted to the area of the state where they are to be planted.
- Consider decorating some areas of the lawn with wood chips, rocks, gravel, or other materials now available that require no water at all.
- Do not "sweep" walks and driveways with the hose. Use a broom or rake instead.
- When washing the car, use a bucket of soapy water and turn on the hose only for rinsing.
- We're more likely to notice leaks indoors, but don't forget to check outdoor faucets, sprinklers, and hoses for leaks.

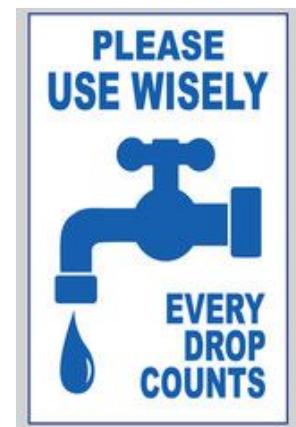

THINGS THAT MAKE YOU GO....HMMM?

Who is North Carolina Rural Water Association?



NCRWA is a non-profit organization dedicated to helping their members attain the highest standard in drinking water and wastewater service. Serving members statewide, NCRWA is governed by a volunteer Board of Directors, elected from the association's membership which includes local governments, sanitary districts, water and sewer authorities, and other non-profit corporations engaged in the distribution/treatment of water and/or the collection/treatment of wastewater in NC.

What is their mission?

To provide their water and wastewater membership with the highest quality support services possible.

They advance their mission by serving their water and wastewater system members in North Carolina through:

- Training;
- Onsite technical, managerial, and financial assistance;
- Member services;
- Networking opportunities; and
- Legislative and regulatory advocacy.

Is there a National Rural Water Association?



Yes! The National Rural Water Association is a non-profit organization dedicated to training, supporting, and promoting the water and wastewater professionals that serve small communities across the United States. The mission of NRWA is to strengthen State Associations.

What is NC811?

Since 1978 NC811 has provided the public with a fast and easy communications link with their local utility providers. The property owner will give us information about the excavation, we transmit the information to the utilities and then the utilities send out locators to mark the publicly managed underground lines for FREE. Contact 811 or 1-800-632-4949 three working days before the customer plans on digging. #SafetyFirst

How do request a locate?



Follow these easy steps:

1. When are working on an outdoor project, mark the area you need to have located.
2. Call 8-1-1 or make a request online three days before you are ready to begin.
3. Wait three days for a response to your request. The utilities in the area will send a locator to mark any underground utility lines.
4. Confirm the utility has responded to your request by comparing the markers listed below.
5. Respect the marks provided by the locators, they are there to make the project safe.
6. Dig carefully. If you can avoid the marked area by moving to a different location, you may want to consider doing so. If not, dig with caution.



Photos from NC811's post in Timeline photos

SUMMER REMINDERS



WCWC will be using chlorine for disinfection purposes as usual July 1st through August 30th.

What is a flushing program?

Water main flushing moves water systematically through sections of a drinking water distribution system, creating a scouring action to clean the line. The increased flow rate scours the water pipe's inner walls and helps to remove build-up of naturally occurring debris and sediment.

How long does water main flushing take?

Hydrant flushing takes about 15 minutes.

Can you shower during hydrant flushing?

Although the water does not pose a health risk, it is recommended to avoid drinking the water until it runs clear. It is ok to use the water for showering, bathing, and toilet flushing.

SAVE WATER IN THE YARD THIS SUMMER

As temperatures rise in the summer, so does our outdoor water use, mostly on lawns and landscapes.

29 billion gallons of daily household water use across the U.S.

9 billion gallons come from daily residential outdoor water use, mainly for landscape irrigation.

Water use spikes in the summer!

Depending on the region, homeowners use **30-60%** of their water outdoors.

50% of that is wasted, in part, due to overwatering.

Average family's water use:

320 gallons per day

During the summer, can be up to

1,000 gallons per day

Some even use up to

3,000 gallons per day

= 100 gallons

—equal to leaving a garden hose running for nearly **8 hours!**

Simple Things We Can All Do

Step on it:
Step on the lawn: if the grass springs back, it doesn't need water.

Leave it long:
Longer grass promotes a more drought-resistant lawn, reduced evaporation, and fewer weeds.

Take a sprinkler break:
Grass isn't really meant to be bright green in the summer.

Simple Things Irrigation System Owners Can Do

Homes with automatic irrigation systems can use about **50%** more water outdoors.

Timing is everything:

Plan to water in the early morning or evening to beat daytime evaporation.

Go with a pro:
Contractors certified through a WaterSense labeled program can audit, install, or maintain home irrigation systems so no water is wasted.

Look for the label:

If your system uses a clock timer, consider upgrading to a WaterSense labeled controller that acts like a thermostat for your lawn, using local weather data to determine when and how much to water. They can reduce irrigation water use by 15%, saving nearly **8,800 gallons** of water per year.

Tune up your system:

Inspect irrigation systems, and fix leaks and broken or clogged sprinkler heads.

Make sure you're watering the lawn, not the sidewalk or driveway!

Just 1 broken sprinkler head could waste up to **25,000** gallons of water and **\$90+** over a 6-month irrigation season — the cost of about 300 daffodil bulbs.

WaterSense, a partnership program by the U.S. Environmental Protection Agency, seeks to protect the future of our nation's water supply. For more tips on reducing outdoor water use, visit www.epa.gov/watersense/outdoor.

WELCOME TO OUR NEW STAFF MEMBERS

Lonnie McKamey - Plant Staff

Myron Cross - Field Staff

Leah Holmes - Part Time CSR

Hailey Paige - CSR

Gabriele Ebner - Accounting